







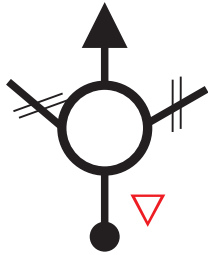

XXIV RALLYE VASCO NAVARRO HISTORICO

SECCION	SECTOR	DE: SALIDA RALLYE - S. SEBASTIAN	DISTANCIA	TIEMPO	PROMEDIO
1	1	A: TR 1 - ARITXULEGI	14,46	30	28,92
			Km.	Min.	Km/h.

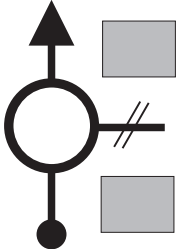
DISTANCIA		DIRECCION	MEDIA KM/H	INFORMACIONES	Kms. REGRES.
TOTAL	PARCIAL				
0,00				<div style="border: 1px solid black; padding: 2px;">PLAZA GIPUZKOA</div> <div style="text-align: right;">N 43° 19' 14" W 1° 58' 56"</div> <div style="text-align: center; font-weight: bold; font-size: 1.2em;">SALIDA RALLYE</div>	14,46
0,07	0,07			<div style="border: 1px solid black; padding: 2px;">C/ IDIAKEZ</div>	14,39
0,16	0,09			<div style="border: 1px solid black; padding: 2px;">AVDA. DE LA LIBERTAD</div>	14,30
0,34	0,18			<div style="border: 1px solid black; padding: 2px;">PTE. SANTA CATALINA / C/ MIRACRUZ</div> <div style="text-align: center; font-weight: bold;">SEGUIR DE FRENTE SIN COGER NINGUN CRUCE</div>	14,12
1,80	1,46			<div style="border: 1px solid black; padding: 2px;">AVDA. ATEGORRIETA</div> <div style="text-align: center; font-weight: bold;">¡OJO! RADAR EN KM 2,52</div> <div style="text-align: center; border: 2px solid red; border-radius: 50%; width: 30px; height: 30px; display: flex; align-items: center; justify-content: center; margin: 0 auto;">50</div>	12,66

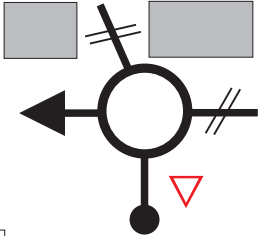
XXIV RALLYE VASCO NAVARRO HISTORICO

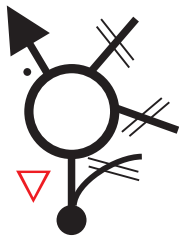
SECCION	SECTOR	DE: SALIDA RALLYE - S. SEBASTIAN	DISTANCIA	TIEMPO	PROMEDIO
1	1	A: TR 1 - ARITXULEGI	14,46 Km.	30 Min.	28,92 Km/h.

DISTANCIA		DIRECCION	MEDIA KM/H	INFORMACIONES	Kms. REGRES.
TOTAL	PARCIAL				
3,16	1,37			<div style="border: 1px solid black; padding: 2px; margin-bottom: 10px;">AVDA. JOSE ELOSEGI</div> 	11,33
3,76	0,59			<div style="border: 1px solid black; padding: 2px; margin-bottom: 10px;">GI-636</div> 	10,74
5,07	1,32			<div style="border: 1px solid black; padding: 2px; margin-bottom: 10px;">GI-636</div>  <p style="text-align: center; font-weight: bold;">"PASAI ANTZO"</p>	9,42
5,92	0,85			<div style="border: 1px solid black; padding: 2px; margin-bottom: 10px;">GI-636</div>  <div style="border: 1px solid black; padding: 5px; display: inline-block; margin-top: 10px;"> <div style="border: 1px solid black; padding: 2px; font-size: 0.8em;">GI-636</div> ERRETERIA 1 </div>	8,57
6,38	0,46			<div style="border: 1px solid black; padding: 2px; margin-bottom: 10px;">GI-636</div> <div style="border: 1px solid black; padding: 5px; display: inline-block; margin-top: 10px;"> <div style="border: 1px solid black; padding: 2px; font-size: 0.8em;">GI-636</div> IRUN BAIONA </div>	8,11

XXIV RALLYE VASCO NAVARRO HISTORICO

SECCION	SECTOR	DE: SALIDA RALLYE - S. SEBASTIAN	DISTANCIA	TIEMPO	PROMEDIO
1	1	A: TR 1 - ARITXULEGI	14,46 Km.	30 Min.	28,92 Km/h.

DISTANCIA		DIRECCION	MEDIA KM/H	INFORMACIONES	Kms. REGRES.
TOTAL	PARCIAL				
6,72	0,34	11		GI-636 	7,74
8,41	1,69	12		GI-636 / GI-2132 = GI-2132 	6,05
8,77	0,36	13		GI-2132 	5,69
9,14	0,37	14		GI-2132 / GI-2134 = GI-2134 	5,32
11,13	1,99	15		GI-2134 	3,33









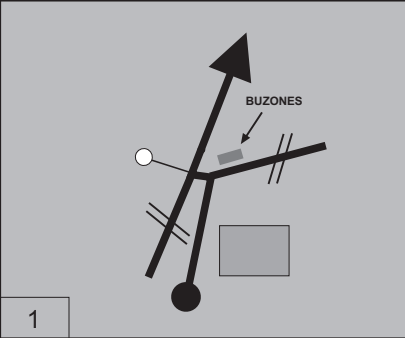

XXIV RALLYE VASCO NAVARRO HISTORICO

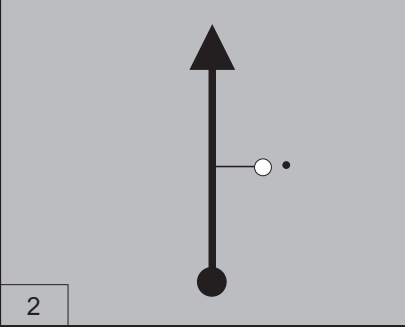
SECCION	SECTOR	DE: SALIDA RALLYE - S. SEBASTIAN	DISTANCIA	TIEMPO	PROMEDIO
1	1	A: TR 1 - ARITXULEGI	14,46 Km.	30 Min.	28,92 Km/h.

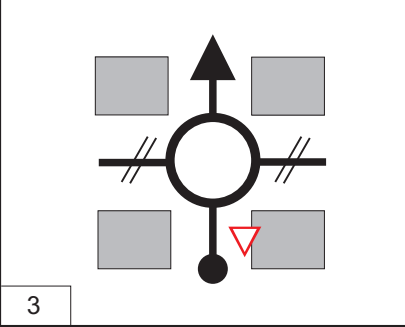
DISTANCIA		DIRECCION	MEDIA KM/H	INFORMACIONES	Kms. REGRES.
TOTAL	PARCIAL				
11,67	0,54	16		GI-2134 / GI-3420 = GI-3420 <div style="border: 1px solid black; padding: 5px; display: inline-block;"> GI-3420 BARRIO ERGOIEN LESAKA </div>	2,79
14,29	2,62	17		POL. INDUSTRIAL ENTRAR EN EL POLIGONO <div style="background-color: #800080; color: white; padding: 5px; display: inline-block;"> Geologia Museoa → </div>	0,17
14,46	0,17	18		GI-3420 <div style="border: 1px solid black; border-radius: 50%; padding: 10px; display: inline-block;"> </div> EN CRUCE FRENTE A LOS BUZONES TR - 1 SALIDA TR - 1	0,00



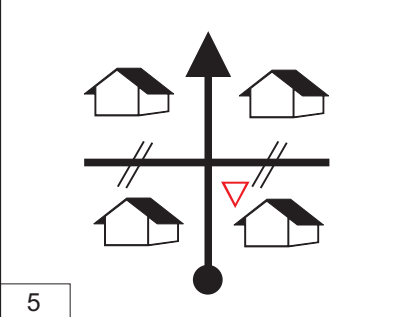





XXIV RALLYE VASCO NAVARRO HISTORICO

SECCION	SECTOR	DE: TR 1 - ARITXULEGI	DISTANCIA	TIEMPO	PROMEDIO
1	1	A: TR 2 - USATEGIETA	40,59 Km.	55 Min.	44,28 Km/h.

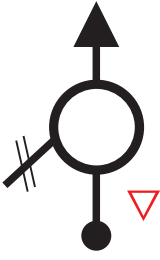
DISTANCIA		DIRECCION	MEDIA KM/H	INFORMACIONES	Kms. REGRES.
TOTAL	PARCIAL				
0,000			49,9	GI-3420 N 43° 17' 11" W 1° 49' 54"  TR - 1 AUTOSALIDA EN CRUCE FRENTE A LOS BUZONES SALIDA TR - 1	40,590
21,675	21,675			NA-4000  TR - 1  LESAKA LLEGADA TR - 1	18,915
22,23	0,56			URBANO 	18,36
22,59	0,36			URBANO  IRUN IRUÑA	18,00
22,68	0,09			URBANO 	17,91

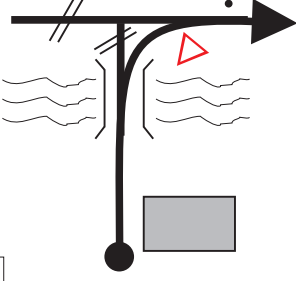
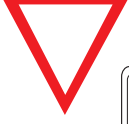

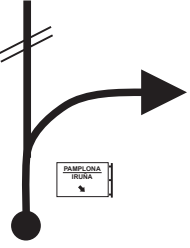
XXIV RALLYE VASCO NAVARRO HISTORICO

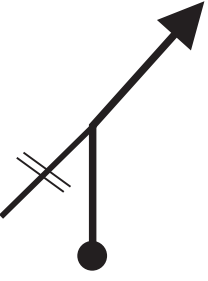
SECCION	SECTOR	DE: TR 1 - ARITXULEGI	DISTANCIA	TIEMPO	PROMEDIO
1	1	A: TR 2 - USATEGIETA	40,59	55	44,28
			Km.	Min.	Km/h.

DISTANCIA		DIRECCION	MEDIA KM/H	INFORMACIONES	Kms. REGRES.
TOTAL	PARCIAL				
23,23	0,55	PROXIMA GASOLINERA: 14,18 km 		URBANO  Gasolinera AVIA	17,36
23,79	0,55			NA-4000 	16,80
24,89	1,12			NA-4000 / NA-1210 = NA-1210  	15,70
25,47	0,56			NA-1210 / NA-121-A = NA-121-A 	15,12
25,79	0,34			NA-121-A INCORPORARSE A LA NA-121-A HASTA SALIDA ORONoz-MUGAIRI	14,80



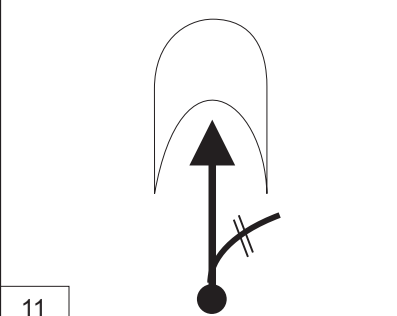
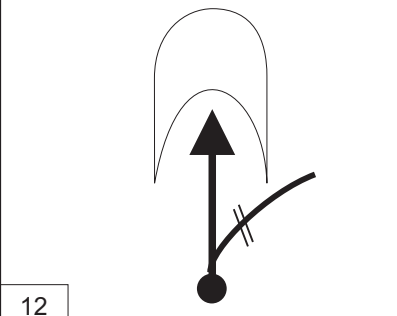
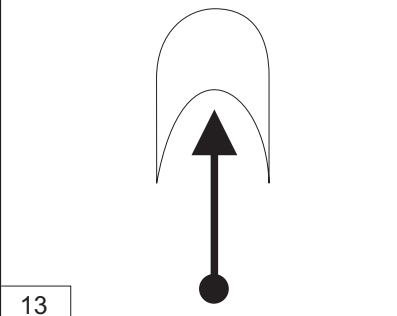
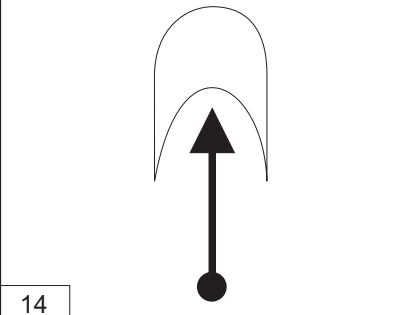
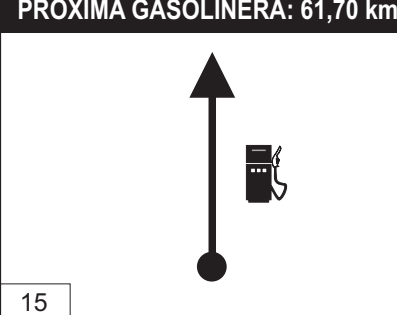





XXIV RALLYE VASCO NAVARRO HISTORICO

SECCION	SECTOR	DE: TR 1 - ARITXULEGI	DISTANCIA	TIEMPO	PROMEDIO
1	1	A: TR 2 - USATEGIETA	40,59 Km.	55 Min.	44,28 Km/h.

DISTANCIA		DIRECCION	MEDIA KM/H	INFORMACIONES	Kms. REGRES.
TOTAL	PARCIAL				
29,19	3,40			<div style="border: 1px solid black; padding: 2px; width: fit-content; margin: 0 auto;">NA-121-A</div> <p style="text-align: center; margin-top: 20px;">tunel BASATAUNDI</p>	11,40
31,80	2,61			<div style="border: 1px solid black; padding: 2px; width: fit-content; margin: 0 auto;">NA-121-A</div> <p style="text-align: center; margin-top: 20px;">tunel LARRAKAITZ</p>	8,79
33,54	1,74			<div style="border: 1px solid black; padding: 2px; width: fit-content; margin: 0 auto;">NA-121-A</div> <p style="text-align: center; margin-top: 20px;">tunel ARRIGAZTELU</p>	7,05
35,69	2,15			<div style="border: 1px solid black; padding: 2px; width: fit-content; margin: 0 auto;">NA-121-A</div> <p style="text-align: center; margin-top: 20px;">tunel SUNBILLA</p>	4,90
37,40	1,71	<p style="background-color: black; color: white; padding: 2px; margin-bottom: 5px;">PROXIMA GASOLINERA: 61,70 km</p> 		<div style="border: 1px solid black; padding: 2px; width: fit-content; margin: 0 auto;">NA-121-A</div> <div style="text-align: center; margin-top: 20px;">  <p>Gasolinera</p> </div>	3,19

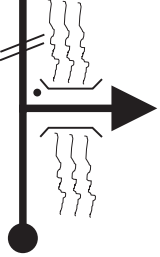

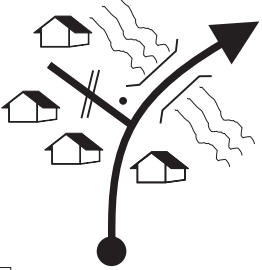
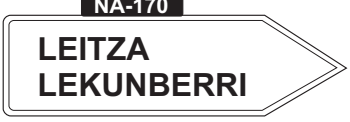
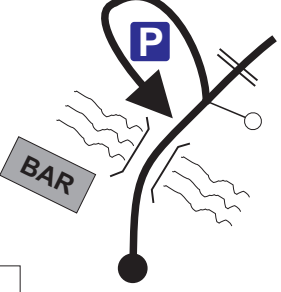



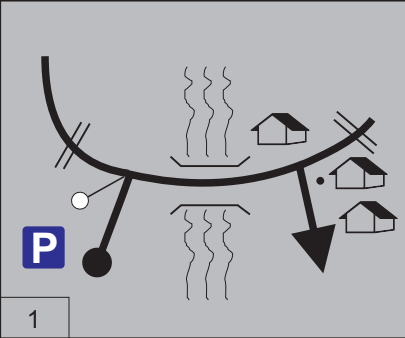

XXIV RALLYE VASCO NAVARRO HISTORICO

SECCION	SECTOR	DE: TR 1 - ARITXULEGI	DISTANCIA	TIEMPO	PROMEDIO
1	1	A: TR 2 - USATEGIETA	40,59 Km.	55 Min.	44,28 Km/h.

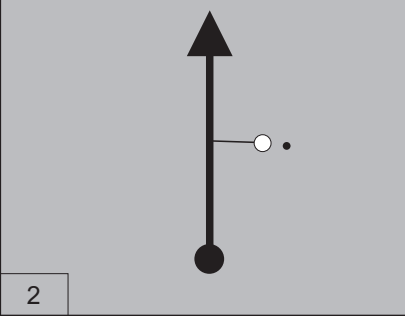
DISTANCIA		DIRECCION	MEDIA KM/H	INFORMACIONES	Kms. REGRES.
TOTAL	PARCIAL				
39,43	2,03	16		NA-121-A / NA-170 = NA-170 	1,16
39,79	0,36	17		NA-170 	0,80
39,86	0,07	18		NA-170  ATRAVESAR PUEBLO CON PRECAUCION	0,73
40,56	0,70	19		NA-170 / NA-4040 = NA-4040 	0,03
40,59	0,03	20		PARKING  ENTRAR EN PARKING BORDATXO PARA TOMAR LA SALIDA SALIDA TR - 2	0,00

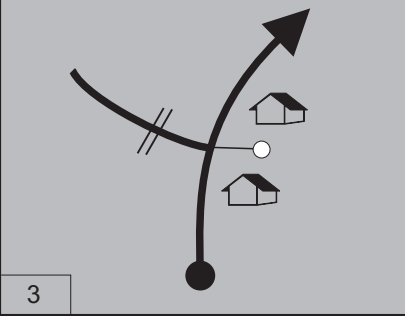
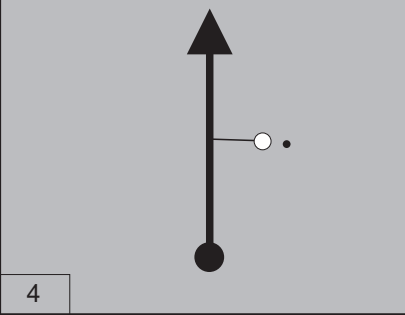

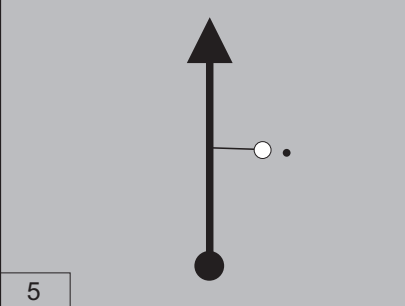
XXIV RALLYE VASCO NAVARRO HISTORICO

SECCION	SECTOR	DE: TR 2 - USATEGIETA	DISTANCIA	TIEMPO	PROMEDIO
1	1	A: TR 3 - BERASTEGI	37,00 Km.	55 Min.	40,36 Km/h.

DISTANCIA		DIRECCION	MEDIA KM/H	INFORMACIONES	Kms. REGRES.
TOTAL	PARCIAL				
0,000			20,0	NA-4040 N 43° 7' 53'' W 1° 40' 18''  SALIDA EN STOP SALIDA PARKING  TR - 2 AUTOSALIDA SALIDA TR - 2	37,000
0,256	0,256		49,9	NA-4040 	36,744
2,732	2,476			NA-4040	34,268
6,330	3,598			NA-4040  	30,670
11,238	4,908		40,0	NA-4040  	25,762



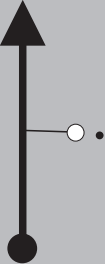
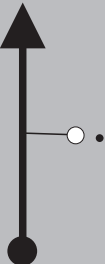
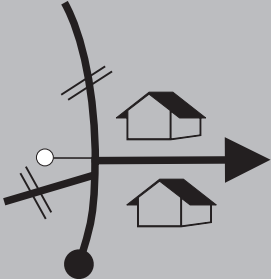
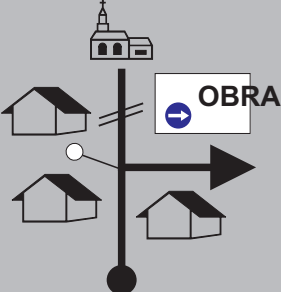

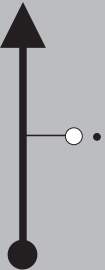



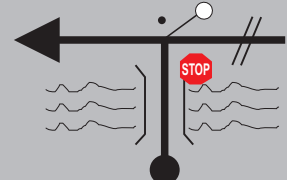

XXIV RALLYE VASCO NAVARRO HISTORICO

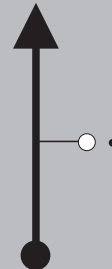
SECCION	SECTOR	DE: TR 2 - USATEGIETA	DISTANCIA	TIEMPO	PROMEDIO
1	1	A: TR 3 - BERASTEGI	37,00 Km.	55 Min.	40,36 Km/h.

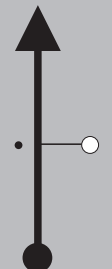
DISTANCIA		DIRECCION	MEDIA KM/H	INFORMACIONES	Kms. REGRES.
TOTAL	PARCIAL				
12,433	1,195	 6	49,9	NA-4040 <div style="border: 1px solid black; padding: 5px; display: inline-block;">BEINTZA LABAIEN</div>	24,567
17,035	4,602	 7	20,0	NA-4040 <div style="border: 1px solid black; padding: 5px; display: inline-block;">SALDIAS</div>	19,965
17,209	6,174	 8		NA-4040 / NA-4029 = NA-4029 "CASCO URBANO" SEGUIR DE FRENTE	19,791
17,427	0,218	 9		NA-4029 	19,573
17,480	0,053	 10	40,0	NA-4029 <div style="border: 1px solid black; padding: 5px; display: inline-block;">SALDIAS</div>	19,520

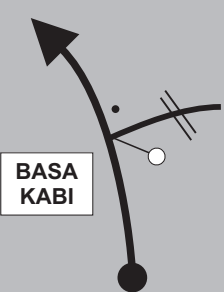

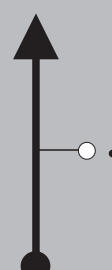

XXIV RALLYE VASCO NAVARRO HISTORICO

SECCION 1	SECTOR 1	DE: TR 2 - USATEGIETA	DISTANCIA 37,00 Km.	TIEMPO 55 Min.	PROMEDIO 40,36 Km/h.
		A: TR 3 - BERASTEGI			

DISTANCIA		DIRECCION	MEDIA KM/H	INFORMACIONES	Kms. REGRES.
TOTAL	PARCIAL				
19,841	2,361		49,9	NA-4029 / NA-170 = NA-170  	17,159
24,458	4,617		40,0	NA-170  	12,542
24,757	0,299		49,9	NA-170 	12,243
31,068	6,311			NA-170 	5,932
35,268	4,200			NA-170  TR - 2  LEITZA LLEGADA TR - 2	1,732

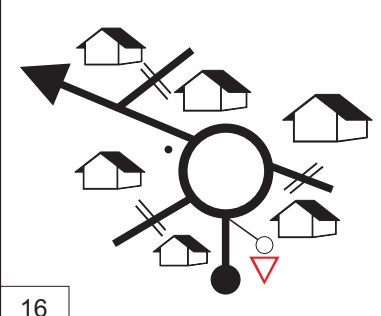

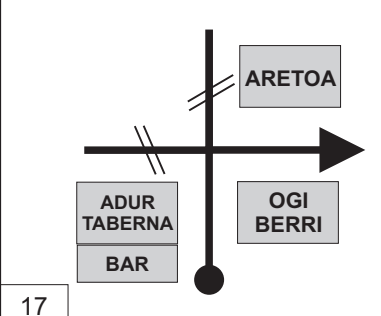
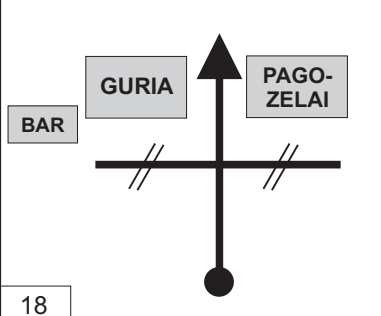
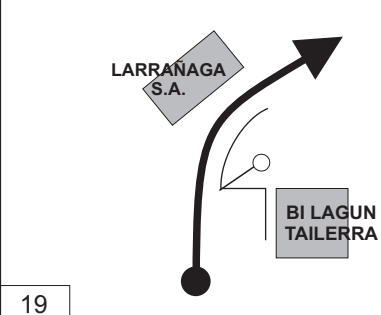





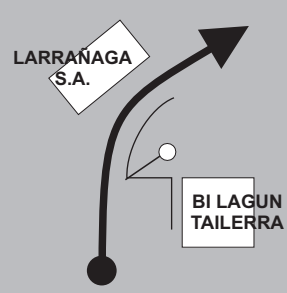

XXIV RALLYE VASCO NAVARRO HISTORICO

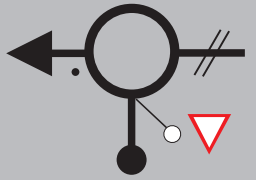
SECCION	SECTOR	DE: TR 2 - USATEGIETA	DISTANCIA	TIEMPO	PROMEDIO
1	1	A: TR 3 - BERASTEGI	37,00 Km.	55 Min.	40,36 Km/h.

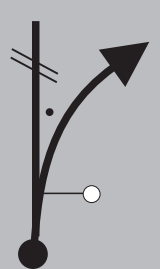
DISTANCIA		DIRECCION	MEDIA KM/H	INFORMACIONES	Kms. REGRES.
TOTAL	PARCIAL				
35,77	0,50	16 		NA-170 / NA-1700 = NA-1700  	1,23
35,96	0,19	17 		URBANO SEGUIR DE FRENTE HASTA POL. INDUSTRIAL	1,04
36,20	0,24	18 		POLIGONO INDUSTRIAL	0,80
37,00	0,80	19 		POLIGONO INDUSTRIAL  TR - 3 SALIDA EN ESQUINA DE BORDILLO SALIDA TR - 3	0,00

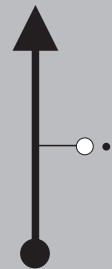

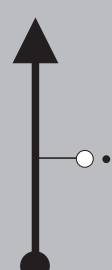



XXIV RALLYE VASCO NAVARRO HISTORICO

SECCION	SECTOR	DE: TR 3 - BERASTEGI	DISTANCIA	TIEMPO	PROMEDIO
1	1	A: PARADA ALEGIA	23,17 Km.	35 Min.	39,72 Km/h.

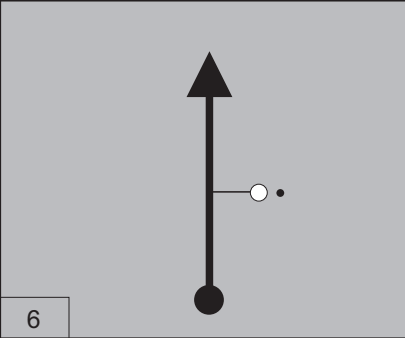
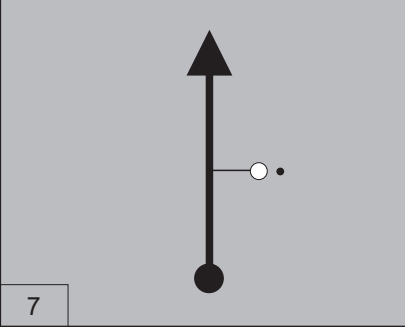
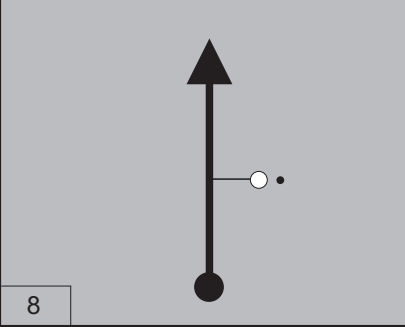
DISTANCIA		DIRECCION	MEDIA KM/H	INFORMACIONES	Kms. REGRES.
TOTAL	PARCIAL				
0,000			49,9	POLIGONO INDUSTRIAL N 43° 05' 07" W 1° 55' 20"  TR - 3 SALIDA EN ESQUINA DE BORDILLO AUTOSALIDA SALIDA TR - 3	23,170
0,078	0,078			NA-170  	23,092
1,724	1,646			NA-170 / NA-1320 = NA-1320 	21,446
3,057	1,333			GI-2130 	20,113
7,352	4,205			GI-2130 	15,818

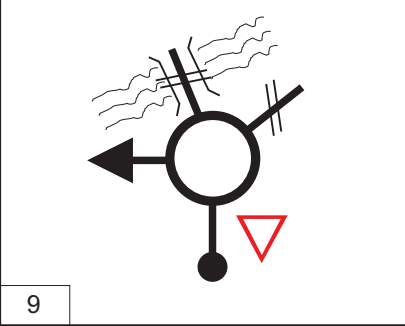

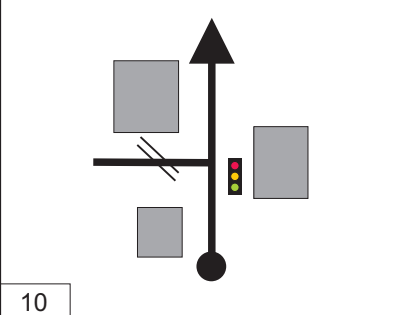



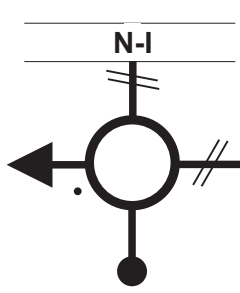

XXIV RALLYE VASCO NAVARRO HISTORICO

SECCION	SECTOR	DE: TR 3 - BERASTEGI	DISTANCIA	TIEMPO	PROMEDIO
1	1	A: PARADA ALEGIA	23,17 Km.	35 Min.	39,72 Km/h.

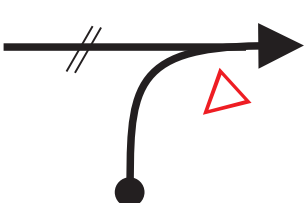
DISTANCIA		DIRECCION	MEDIA KM/H	INFORMACIONES	Kms. REGRES.
TOTAL	PARCIAL				
10,780	3,428			GI-2130 ELDUAIN	12,390
12,872	2,092			GI-2130 BERROBI	10,298
16,866	3,994			GI-2130  TR - 3 IBARRA LLEGADA TR - 3	6,304
18,01	1,14			KONDEANEKO ALDAPA  "TOLOSA"	5,16
18,44	0,43			KONDEANEKO ALDAPA  CASCO URBANO	4,73

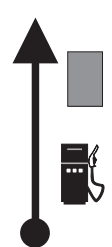



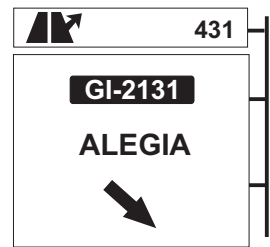
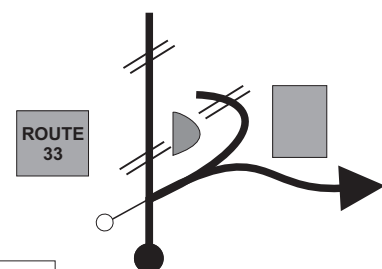

XXIV RALLYE VASCO NAVARRO HISTORICO

SECCION	SECTOR	DE: TR 3 - BERASTEGI	DISTANCIA	TIEMPO	PROMEDIO
1	1	A: PARADA ALEGIA	23,17 Km.	35 Min.	39,72 Km/h.

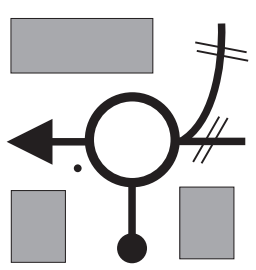
DISTANCIA		DIRECCION	MEDIA KM/H	INFORMACIONES	Kms. REGRES.
TOTAL	PARCIAL				
18,95	0,51			N-I  	4,22
19,37	0,42			N-I  INCORPORARSE A LA N-I HASTA SALIDA 431	3,80
21,35	1,98	PROXIMA GASOLINERA: 50,48 km 		N-I  GASOLINERA REPSOL !! OJO !! RADAR 	1,82
22,35	1,00			N-I / GI-2131 = GI-2131 	0,82
22,73	0,38	ROUTE 33 		POLIGONO INDUSTRIAL	0,44

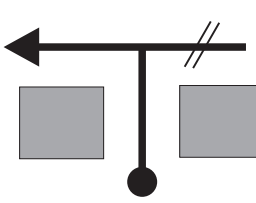

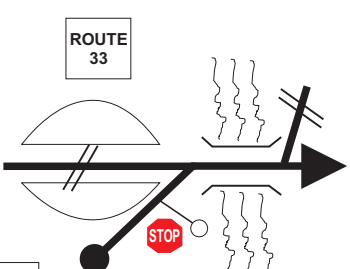



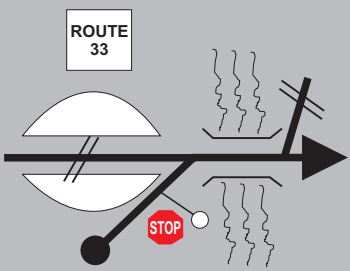

XXIV RALLYE VASCO NAVARRO HISTORICO

SECCION	SECTOR	DE: TR 3 - BERASTEGI	DISTANCIA	TIEMPO	PROMEDIO
1	1	A: PARADA ALEGIA	23,17	35	39,72
			Km.	Min.	Km/h.

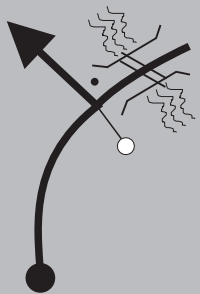
DISTANCIA		DIRECCION	MEDIA KM/H	INFORMACIONES	Kms. REGRES.	
TOTAL	PARCIAL					
22,92	0,19				0,25	
22,98	0,06				0,19	
23,05	0,07			PARADA ALEGIA 	0,12	
23,17	0,12			 TR - 4 AUTOSALIDA	 STOP SALIDA EN SEÑAL SALIDA TR - 4	0,00

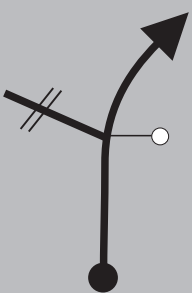
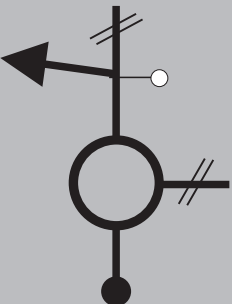

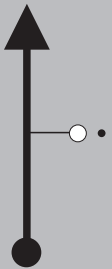



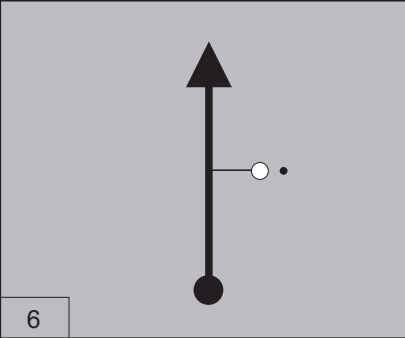

XXIV RALLYE VASCO NAVARRO HISTORICO

SECCION	SECTOR	DE: TR 4 - LIZARTZA	DISTANCIA	TIEMPO	PROMEDIO
1	1	A: TR 5 - MADOTZ	32,48 Km.	50 Min.	38,98 Km/h.

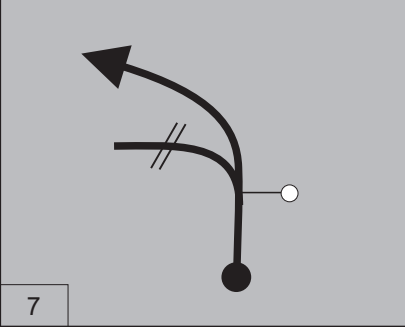
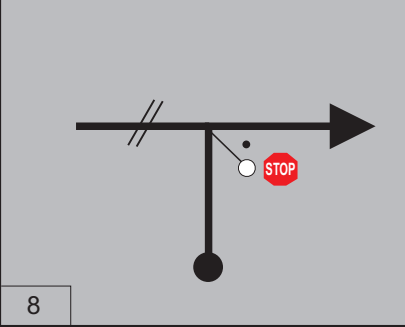
DISTANCIA		DIRECCION	MEDIA KM/H	INFORMACIONES	Kms. REGRES.
TOTAL	PARCIAL				
0,000			49,9	GI-2131 N 43° 06' 32" W 2° 05' 47"   TR - 4 SALIDA EN SEÑAL SALIDA AUTOSALIDA TR - 4	32,480
0,397	0,397			GI-2131 / GI-2133 = GI-2133  3 ALTZO 7 ORENDAIN	32,083
0,482	0,085			GI-2133	31,998
1,793	0,091			GI-2133 / GI-3620 = GI-3620  2 ALTZO	30,687
3,100	1,307		20,0	GI-3620  ALTZO	29,380

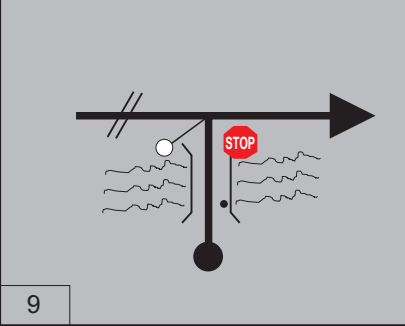
XXIV RALLYE VASCO NAVARRO HISTORICO

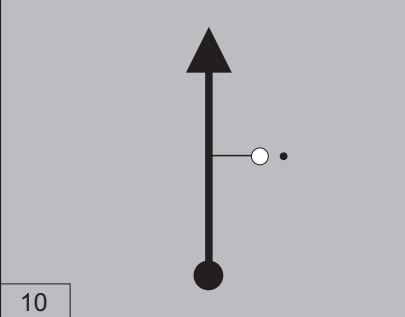
SECCION	SECTOR	DE: TR 4 - LIZARTZA	DISTANCIA	TIEMPO	PROMEDIO
1	1	A: TR 5 - MADOTZ	32,48 Km.	50 Min.	38,98 Km/h.

DISTANCIA		DIRECCION	MEDIA KM/H	INFORMACIONES	Kms. REGRES.
TOTAL	PARCIAL				
3,593	0,493		49,9	GI-3620 	28,887
4,465	0,872			GI-3620	28,015
4,740	0,275			GI-3620 	27,740
6,112	1,372			GI-2135 	26,368
10,107	3,995		40,0	GI-2135 	22,373





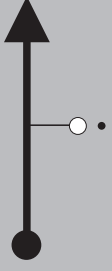
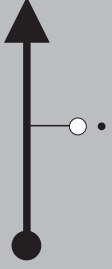
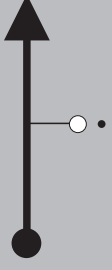
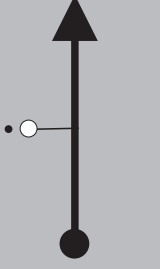
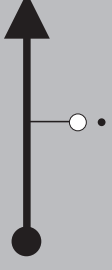

XXIV RALLYE VASCO NAVARRO HISTORICO

SECCION	SECTOR	DE: TR 4 - LIZARTZA	DISTANCIA	TIEMPO	PROMEDIO
1	1	A: TR 5 - MADOTZ	32,48 Km.	50 Min.	38,98 Km/h.

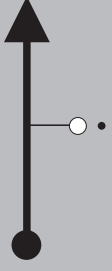
DISTANCIA		DIRECCION	MEDIA KM/H	INFORMACIONES	Kms. REGRES.
TOTAL	PARCIAL				
10,758	0,651		49,9	<div style="border: 1px solid black; padding: 2px; margin-bottom: 10px;">GI-2135</div> <div style="border: 1px solid black; padding: 5px; display: inline-block; text-align: center;"> LIZARTZA </div>	21,722
14,832	4,074			<div style="border: 1px solid black; padding: 2px; margin-bottom: 10px;">NA-1300</div> <div style="border: 2px solid red; padding: 5px; display: inline-block; text-align: center; color: white;"> NAVARRA NAFARROA </div>	17,648
19,147	4,315			<div style="border: 1px solid black; padding: 2px; margin-bottom: 10px;">NA-1300</div> <div style="border: 1px solid black; padding: 5px; display: inline-block; text-align: center;"> ATALLU </div>	13,333
19,739	0,592			<div style="border: 1px solid black; padding: 2px; margin-bottom: 10px;">NA-1300</div> <div style="border: 1px solid black; padding: 5px; display: inline-block; text-align: center;"> ARRIBE </div>	12,741
21,181	1,442			<div style="border: 1px solid black; padding: 2px; margin-bottom: 10px;">NA-1300</div> <div style="border: 1px solid black; padding: 5px; display: inline-block; text-align: center;"> BETELU </div>	11,299

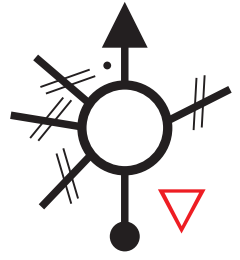

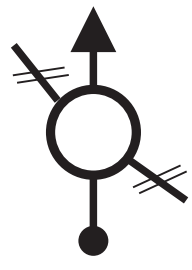
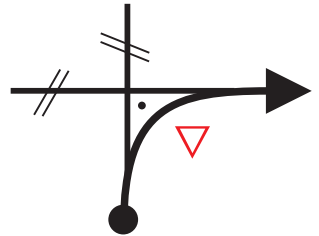

XXIV RALLYE VASCO NAVARRO HISTORICO

SECCION	SECTOR	DE: TR 4 - LIZARTZA	DISTANCIA	TIEMPO	PROMEDIO
1	1	A: TR 5 - MADOTZ	32,48	50	38,98
			Km.	Min.	Km/h.

DISTANCIA		DIRECCION	MEDIA KM/H	INFORMACIONES	Kms. REGRES.
TOTAL	PARCIAL				
29,008	7,827			NA-1300  TR - 4  LLEGADA TR - 4	3,472
30,33	1,32			NA-1300  LEKUNBERRI	2,15
30,46	0,13			NA-1300 LEKUNBERRI	2,02
31,14	0,68			NA-1300 ATRAVESAR PUEBLO CON PRECAUCION	1,34
32,09	0,95			NA-1300 / NA-7510 = NA-7510  BARAIBAR	0,39





XXIV RALLYE VASCO NAVARRO HISTORICO

SECCION	SECTOR	DE:	DISTANCIA	TIEMPO	PROMEDIO
1	1	TR 4 - LIZARTZA	32,48 Km.	50 Min.	38,98 Km/h.
		TR 5 - MADOTZ			

DISTANCIA		DIRECCION	MEDIA KM/H	INFORMACIONES	Kms. REGRES.
TOTAL	PARCIAL				
32,43	0,34			NA-7510 ZONA DE ESPERA PARA SALIDA (LA SIDRERIA ESTA CERRADA)	0,05
32,48	0,05			NA-7510   TR - 5 EN FAROLA ESQUINA CASA SALIDA TR - 5	0,00
				<input style="width: 100%; height: 20px;" type="text"/>	
				<input style="width: 100%; height: 20px;" type="text"/>	
				<input style="width: 100%; height: 20px;" type="text"/>	

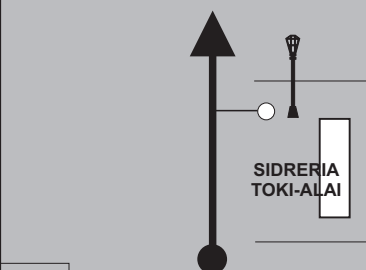

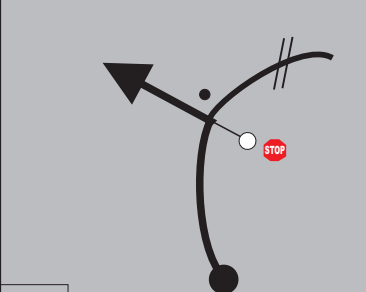

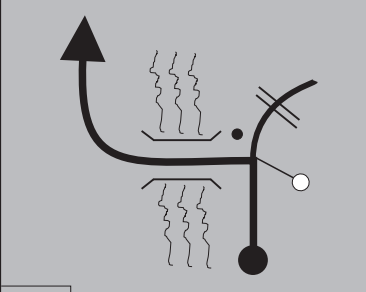
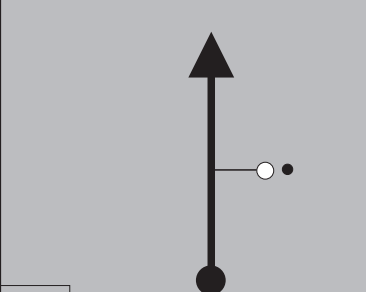
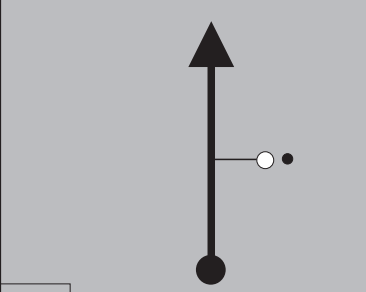

XXIV RALLYE VASCO NAVARRO HISTORICO

SECCION	SECTOR	DE: TR 5 - MADOTZ	DISTANCIA	TIEMPO	PROMEDIO
1	1	A: TR 6 - LIZARRUSTI	32,43 Km.	45 Min.	43,24 Km/h.

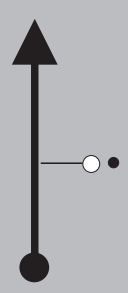
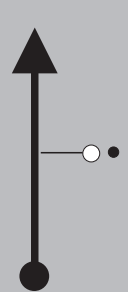
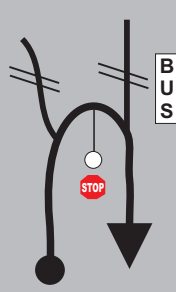
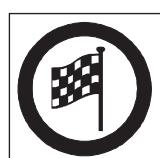
DISTANCIA		DIRECCION	MEDIA KM/H	INFORMACIONES	Kms. REGRES.
TOTAL	PARCIAL				
0,000			49,9	NA-7510 N 42° 59' 53" W 1° 53' 36"   EN FAROLA ESQUINA CASA SALIDA TR - 5	32,430
0,274	0,274			NA-7510 / NA-7500 = NA-7500  <div style="border: 1px solid black; padding: 5px; display: inline-block; text-align: center;"> NA-7500 IRIBAS ALLI ASTITZ ODERITZ MADOTZ </div>	32,156
0,476	0,202			NA-7500 <div style="border: 1px solid black; padding: 5px; display: inline-block;"> 9 MADOTZ </div>	31,954
1,098	0,622			NA-7500 <div style="border: 1px solid black; padding: 5px; display: inline-block;"> ALLI </div>	31,32
3,954	2,856			NA-7500 <div style="border: 1px solid black; padding: 5px; display: inline-block;"> ASTITZ </div>	28,476

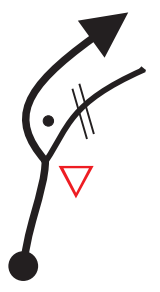

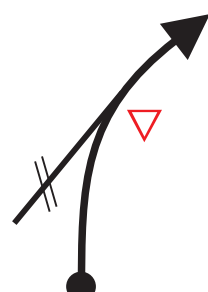



XXIV RALLYE VASCO NAVARRO HISTORICO

SECCION	SECTOR	DE: TR 5 - MADOTZ	DISTANCIA	TIEMPO	PROMEDIO
1	1	A: TR 6 - LIZARRUSTI	32,43 Km.	45 Min.	43,26 Km/h.

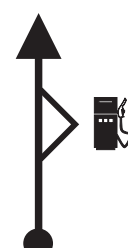
DISTANCIA		DIRECCION	MEDIA KM/H	INFORMACIONES	Kms. REGRES.
TOTAL	PARCIAL				
6,352	2,398			NA-7500 <div style="border: 1px solid black; padding: 5px; width: fit-content; margin: auto;">ODERITZ</div>	26,078
8,197	1,845			NA-7500 <div style="border: 1px solid black; padding: 5px; width: fit-content; margin: auto;">MADOTZ</div>	24,233
14,695	6,498			NA-7500 / NA-2410 = NA-2410 <div style="display: flex; justify-content: space-around; align-items: center;"> <div style="text-align: center;">  TR - 5 </div> <div style="text-align: center;">  LLEGADA TR - 5 </div> </div> <p style="text-align: center; font-weight: bold;">¡OJO! PROXIMO CRUCE INMEDIATO</p>	17,735
14,77	0,07			NA-2410 / A-10 = A-10 <div style="text-align: center;">  <div style="border: 2px solid blue; padding: 5px; background-color: white; width: fit-content; margin: auto;"> ALSASUA / ALTSASU Vitoria / Gasteiz </div> </div>	17,66
14,96	0,19			A-10 <div style="text-align: center;">  INCORPORARSE A LA A-10 DIRECCION VITORIA HASTA SALIDA 12 </div>	17,47

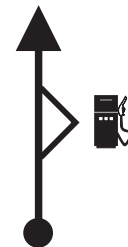
XXIV RALLYE VASCO NAVARRO HISTORICO

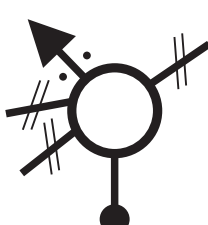
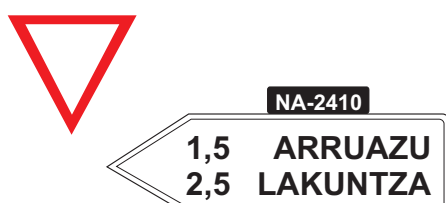
SECCION	SECTOR	DE: TR 5 - MADOTZ	DISTANCIA	TIEMPO	PROMEDIO
1	1	A: TR 6 - LIZARRUSTI	32,43	45	43,24
			Km.	Min.	Km/h.

DISTANCIA		DIRECCION	MEDIA KM/H	INFORMACIONES	Kms. REGRES.
TOTAL	PARCIAL				
16,50	1,54	PROXIMA GASOLINERA: 2,38 km 		A-10  SALIDA 2 Gasolinera REPSOL	15,93
18,88	2,38	PROXIMA GASOLINERA: 10,57 km 		A-10 GASOLINERA CERRADA	13,55
26,37	7,49			A-10 / NA-2410 = NA-2410  DEJAR LA A-10 EN LA SALIDA 12	6,06
26,73	0,36			NA-2410 	5,70
28,12	1,39			NA-2410	4,31









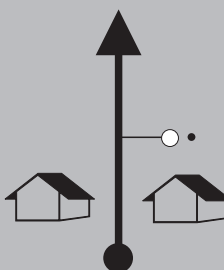

XXIV RALLYE VASCO NAVARRO HISTORICO

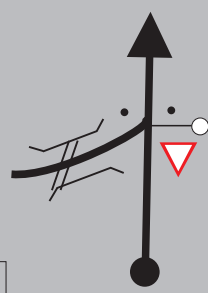
SECCION	SECTOR	DE: TR 5 - MADOTZ	DISTANCIA	TIEMPO	PROMEDIO
1	1	A: TR 6 - LIZARRUSTI	32,43	45	43,26
			Km.	Min.	Km/h.

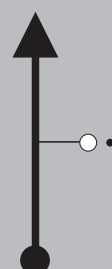
DISTANCIA		DIRECCION	MEDIA KM/H	INFORMACIONES	Kms. REGRES.
TOTAL	PARCIAL				
29,18	1,06	PROXIMA GASOLINERA: 25,67km 		NA-2410 Gasolinera CEPSA	3,25
30,90	1,72			NA-2410 <div style="border: 1px solid black; padding: 5px; width: fit-content; margin: 0 auto;">ARBIZU</div>	1,53
31,57	0,67			NA-2410 / NA-7520 = NA-7520 <div style="border: 1px solid black; padding: 5px; width: fit-content; margin: 0 auto;"> NA-7520 LIZARRAGABENGOA BEASAIN 34 </div>	0,86
32,32	0,75			NA-7520 <div style="border: 1px solid black; padding: 5px; width: fit-content; margin: 0 auto;">LIZARRAGABENGOA</div>	0,11
32,43	0,11			NA-7520 <div style="display: flex; align-items: center; justify-content: center;"> <div style="border: 1px solid black; padding: 2px;"> LIZARRAGABENGOA </div> </div> TR - 6 SALIDA TR - 6	0,00

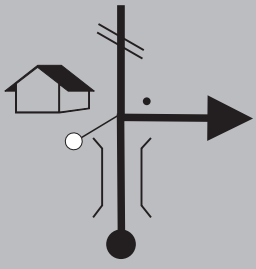

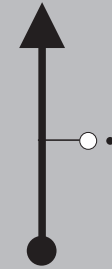

XXIV RALLYE VASCO NAVARRO HISTORICO

SECCION	SECTOR	DE: TR 6 - LIZARRUSTI	DISTANCIA	TIEMPO	PROMEDIO
1	1	A: ZUMARRAGA	40,61 Km.	65 Min.	37,49 Km/h.

DISTANCIA		DIRECCION	MEDIA KM/H	INFORMACIONES	Kms. REGRES.
TOTAL	PARCIAL				
0,000			49,9	NA-7520 N 42° 55' 08" W 2° 02' 57"  TR - 6  AUTOSALIDA SALIDA TR - 6	40,610
1,042	1,042			NA-7520 / NA-120 = NA-120  	39,568
6,970	5,928			GI-2120 	33,640
13,210	6,240		40,0	GI-2120 / GI-3151 = GI-3151 	27,400
14,649	1,439		20,0	GI-3151 	25,961

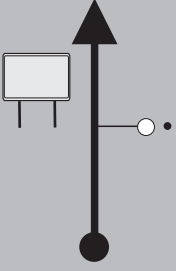
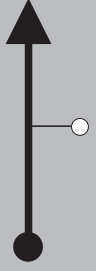
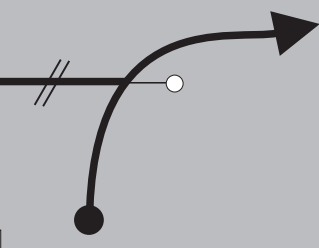
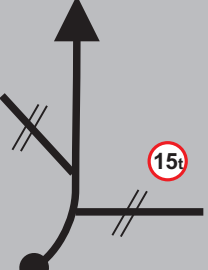

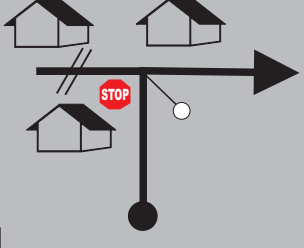







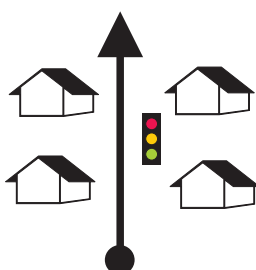



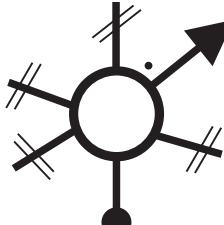
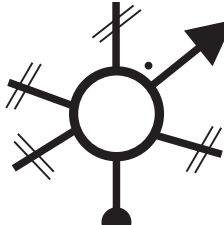

XXIV RALLYE VASCO NAVARRO HISTORICO

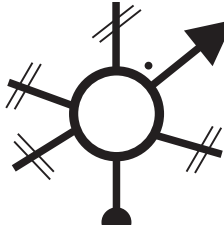
SECCION	SECTOR	DE: TR 6 - LIZARRUSTI	DISTANCIA	TIEMPO	PROMEDIO
1	1	A: ZUMARRAGA	40,61	65	37,49
			Km.	Min.	Km/h.

DISTANCIA		DIRECCION	MEDIA KM/H	INFORMACIONES	Kms. REGRES.
TOTAL	PARCIAL				
14,844	0,195		40,0	<div style="border: 1px solid black; padding: 2px; width: fit-content; margin: 0 auto;">GI-3151</div>	25,766
15,460	0,616			<div style="border: 1px solid black; padding: 2px; width: fit-content; margin: 0 auto;">GI-3151</div> <p style="text-align: center; margin-top: 10px;">ZONA EN OBRAS 500 mts SIN CONTROL</p>	25,150
15,975	0,515			<div style="border: 1px solid black; padding: 2px; width: fit-content; margin: 0 auto;">GI-3151</div>	24,635
16,032	0,057		49,9	<div style="border: 1px solid black; padding: 2px; width: fit-content; margin: 0 auto;">GI-3151</div> <div style="text-align: center; margin-top: 20px;">  </div>	24,578
19,929	3,897			<div style="border: 1px solid black; padding: 2px; width: fit-content; margin: 0 auto;">GI-3151 / GI-2120 = GI-2120</div> <div style="display: flex; justify-content: space-around; margin-top: 10px;"> <div style="text-align: center;">  TR - 6 </div> <div style="text-align: center;">  </div> </div> <div style="text-align: right; margin-top: 10px;"> LLEGADA TR - 6 </div>	20,681

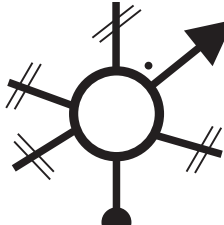







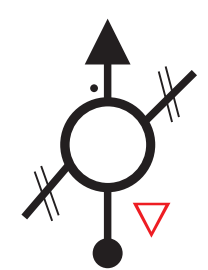

XXIV RALLYE VASCO NAVARRO HISTORICO

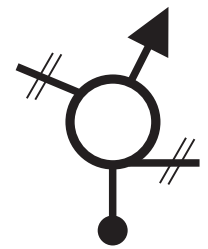
SECCION	SECTOR	DE: TR 6 - LIZARRUSTI	DISTANCIA	TIEMPO	PROMEDIO
1	1	A: ZUMARRAGA	40,61	65	37,49
			Km.	Min.	Km/h.

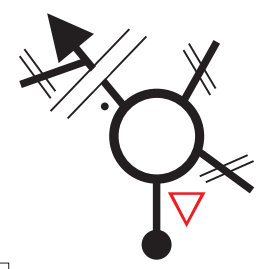
DISTANCIA		DIRECCION	MEDIA KM/H	INFORMACIONES	Kms. REGRES.
TOTAL	PARCIAL				
21,24	1,31	<div style="border: 1px solid black; padding: 2px;">11</div> 		<div style="border: 1px solid black; padding: 2px;">GI-2120</div>  <p style="text-align: center;">¡ATENCIÓN! TRAVESIA ESTRECHA ZONA PEATONAL</p>	19,37
		<div style="background-color: black; color: white; padding: 2px; font-weight: bold;">PROXIMA GASOLINERA: 3,23 km</div> 		<div style="border: 1px solid black; padding: 2px;">GI-2120</div>  <p style="text-align: center;">Gasolinera AVIA</p>	
22,36	1,12	<div style="border: 1px solid black; padding: 2px;">12</div> 		<div style="border: 1px solid black; padding: 2px;">GI-2120</div>  <p style="text-align: center;">Gasolinera AVIA</p>	18,25
		<div style="border: 1px solid black; padding: 2px;">13</div> 		<div style="border: 1px solid black; padding: 2px;">GI-2120</div> <div style="border: 1px solid black; padding: 5px; display: inline-block; margin-top: 10px;"> <div style="background-color: black; color: white; padding: 2px; font-weight: bold; font-size: 8px;">GI-2120</div> BEASAIN </div>	16,76
23,85	1,49	<div style="border: 1px solid black; padding: 2px;">13</div> 		<div style="border: 1px solid black; padding: 2px;">GI-2120</div>  <div style="border: 1px solid black; padding: 5px; display: inline-block; margin-top: 10px;"> BEASAIN <div style="background-color: black; color: white; padding: 2px; font-weight: bold; font-size: 8px;">GI-2120</div> </div>	15,28
		<div style="border: 1px solid black; padding: 2px;">14</div> 		<div style="border: 1px solid black; padding: 2px;">GI-2120</div>  <div style="border: 1px solid black; padding: 5px; display: inline-block; margin-top: 10px;"> BEASAIN <div style="background-color: black; color: white; padding: 2px; font-weight: bold; font-size: 8px;">GI-2120</div> </div>	
		<div style="background-color: black; color: white; padding: 2px; font-weight: bold;">PROXIMA GASOLINERA: 3,37 km</div> 		<div style="border: 1px solid black; padding: 2px;">GI-2120</div>  <p style="text-align: center;">Gasolinera AVIA</p>	
25,33	1,48	<div style="border: 1px solid black; padding: 2px;">14</div> 		<div style="border: 1px solid black; padding: 2px;">GI-2120</div>  <div style="border: 1px solid black; padding: 5px; display: inline-block; margin-top: 10px;"> BEASAIN <div style="background-color: black; color: white; padding: 2px; font-weight: bold; font-size: 8px;">GI-2120</div> </div>	15,28
		<div style="border: 1px solid black; padding: 2px;">15</div> 		<div style="border: 1px solid black; padding: 2px;">GI-2120</div>  <p style="text-align: center;">Gasolinera AVIA</p>	15,03
25,58	0,25				15,03

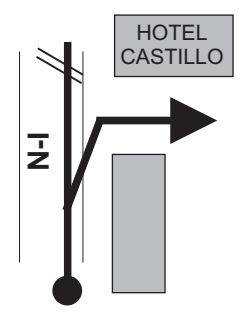

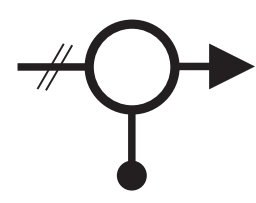



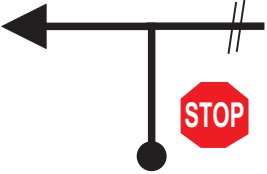

XXIV RALLYE VASCO NAVARRO HISTORICO

SECCION	SECTOR	DE: TR 6 - LIZARRUSTI	DISTANCIA	TIEMPO	PROMEDIO
1	1	A: ZUMARRAGA	40,61 Km.	65 Min.	37,49 Km/h.

DISTANCIA		DIRECCION	MEDIA KM/H	INFORMACIONES	Kms. REGRES.
TOTAL	PARCIAL				
25,95	0,37	16		GI-2120  	14,66
26,18	0,23	17		GI-2120 	14,43
26,46	0,28	18		GI-2120 / N-I = N-I   INCORPORARSE A LA N-I HASTA SALIDA 418	14,15
28,27	1,57	19		N-I / GI-2632 = GI-2632 	12,34
28,49	0,22	20		GI-2632 	12,12

XXIV RALLYE VASCO NAVARRO HISTORICO

SECCION	SECTOR	DE: TR 6 - LIZARRUSTI	DISTANCIA	TIEMPO	PROMEDIO
1	1	A: ZUMARRAGA	40,61 Km.	65 Min.	37,49 Km/h.

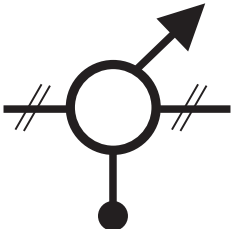
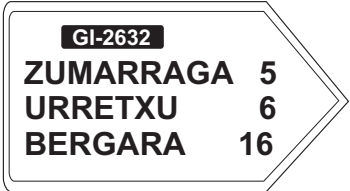
DISTANCIA		DIRECCION	MEDIA KM/H	INFORMACIONES	Kms. REGRES.
TOTAL	PARCIAL				
28,96	0,47	 <small>21</small>		GI-632 / GI-2632 = GI-2632 	11,65
31,82	2,86	 <small>22</small>		GI-2632 	8,79
32,63	0,81	 <small>23</small>		GI-2632 	7,98
34,25	1,62	 <small>24</small>		GI-2632 	6,36
35,99	1,74	 <small>25</small>		GI-2632 	4,62

XXIV RALLYE VASCO NAVARRO HISTORICO

SECCION	SECTOR	DE: TR 6 - LIZARRUSTI	DISTANCIA	TIEMPO	PROMEDIO
1	1	A: ZUMARRAGA	40,61	65	37,49
			Km.	Min.	Km/h.

DISTANCIA		DIRECCION	MEDIA KM/H	INFORMACIONES	Kms. REGRES.
TOTAL	PARCIAL				
37,94	1,95			GI-2632 	2,67
40,04	2,10			GI-2632 / C. San Gregorio 	0,57
40,51	0,47			Elizkale kalea	0,10
40,61	0,10			Elizkale kalea ¡¡¡ ATENCION !!! ENTRADA AL PARQUE POR EL PASO DE CEBRA	0,00